

Panasonic

2.4 GHz Portable Station

Operating Instructions

Model No. KX-TD7680



Thank you for purchasing the Panasonic KX-TD7680, 2.4 GHz Portable Station. Please read this manual carefully before using this product and save this manual for future use.

This manual is designed to be used with your Portable Station and a Panasonic KX-TDA series Business Telephone System.

Charge the battery for about 7 hours before initial use.



Before Initial Use

Please read "IMPORTANT SAFETY INSTRUCTIONS" on page 44 before use.
Read and understand all instructions.

◆ Registration

Your Portable Station (PS) must be registered in the Business Telephone System and assigned an extension number before initial use.

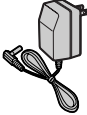
◆ Accessories (☐-included/ ■-optional)

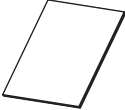
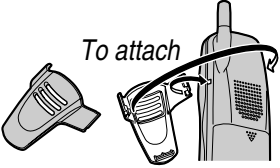
<input type="checkbox"/> Charger  <p style="text-align: right;">One</p>	<input type="checkbox"/> AC adaptor (KX-TCA1)  <p style="text-align: right;">One</p>	<input type="checkbox"/> Battery (N4HHGMB00001)  <p style="text-align: right;">One</p>
<input type="checkbox"/> Screws and Washers  <p style="text-align: right;">Two</p>	<input type="checkbox"/> Operating Instructions  <p style="text-align: right;">One</p>	<input type="checkbox"/> Belt Clip  <p style="text-align: right;">One</p>
<input checked="" type="checkbox"/> Carrying Case Option		
<input checked="" type="checkbox"/> Headset * Option		



- For extra orders, call toll-free **1-800-332-5368**.
- * Please use only the Panasonic KX-TCA86/KX-TCA88/KX-TCA91/KX-TCA92 headset.

Table of Contents

Before Initial Use	2
Before Operating the PS	4
Location of Controls	4
Setting Up	5
Charging	5
Wall Mounting	5
Power On/Off	6
Signal Search (Cell Search)	6
Locking the Keypads	6
Display	7
Operation Outline	8
Key Operation	10
Flexible-CO Key Display	11
Ringer Volume Adjustment	12
Receiver Volume Adjustment	12
Making Calls	13
Calling Another Extension	13
Calling an Outside Party	13
Using the Call Log	14
Making Calls Using the Directories	15
Receiving Calls	17
Intercom Calls/Outside Calls/Group Calls	17
During a Conversation	19
Transferring a Call	19
Holding	19
Hands-free/Monitor Conversation	20
Using the Directories	21
Directories	21
Quick Dialing	21
PS Dialing Directory	23
Entering Characters	27
Other Operations	29
Programming	33
Changing the Initial Settings	33
Troubleshooting	41
Troubleshooting for Portable Station	41
Important Information	43

Before Operating the PS

◆◆ Location of Controls

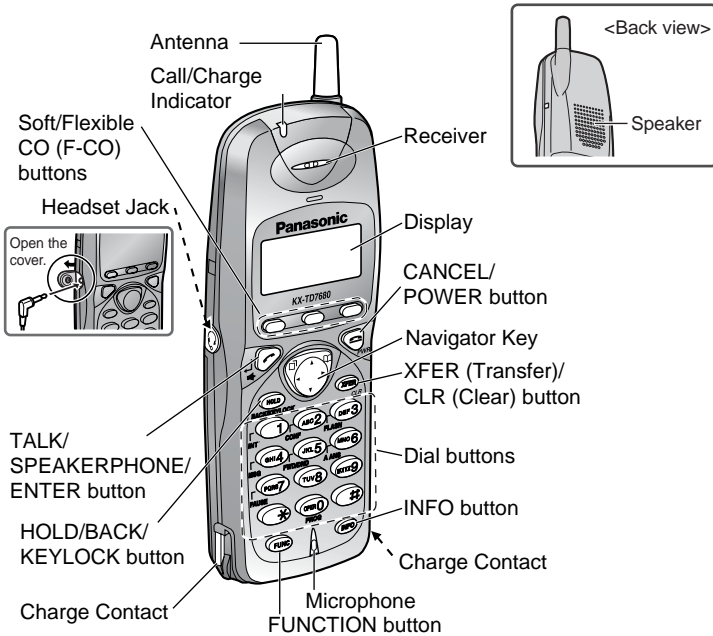

TALK/SPEAKERPHONE/ENTER button:

Used to make or receive calls, for the hands-free operation, and to confirm the entered setting.



INFO button:

Used to display the flexible-CO key.



HOLD/BACK/KEYLOCK button:

Used to place a call on hold, return to the previous display, and to lock/unlock the dialing buttons.



XFER (Transfer)/CLR (Clear) button:

Used to transfer a call to another party, clear digits or characters.



FUNCTION button:

Used to enter the FUNCTION mode or activate a specific key with a combination of each dialing button.



NAVIGATOR key:

Used to adjust the ringer/receiver volume or move the cursor to select a desired item. To select an item, press the arrow repeatedly.



CANCEL/POWER button:

Used to end calls, exit the Directory or Function mode, turn the ringer and vibration off while receiving a call, or turn on/off the PS.

Before Operating the PS

◆◆ Setting Up

- 1 Open the battery cover.
- 2 Install the battery.
- 3 Close the cover.

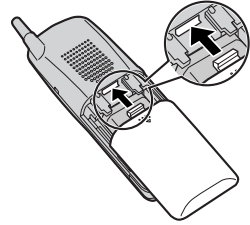
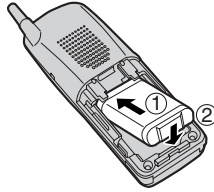
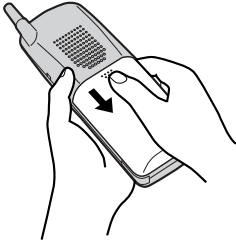

◆◆ Charging

- 1 Connect the charger to a power outlet using the AC adaptor.
- 2 Charge the battery for about 7 hours.

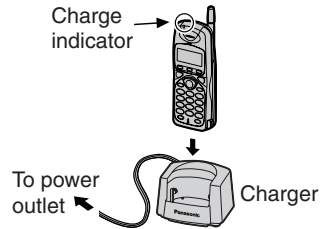
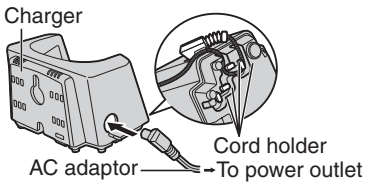

- When the battery has been completely charged, the charge indicator will change from red to green. Refer to "Battery Information" on page 43.
- It is normal for the PS and charger to get warm while the battery is charging.

◆◆ Wall Mounting

- 1 Connect a AC adaptor to the charger.
- 2 Drive the included screws into the wall using the wall template below.

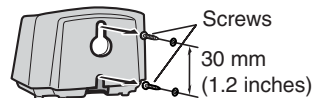
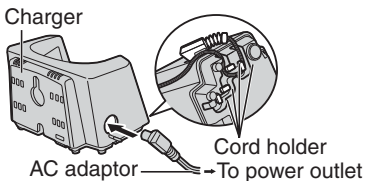

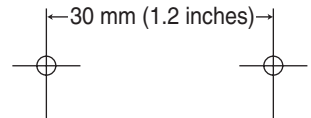

- 3 Mount the charger securely on the screws.



Before Operating the PS

◆◆ Power On/Off



<p>Power On</p>  <p>Press POWER for about 2 seconds, and “KX-TD7680” will be displayed.</p>	<p>Power Off</p>  <p>Press POWER for about 2 seconds. The display will go blank.</p>
--	---



- When the PS is turned on, it will be in standby mode. Standby mode is the state of the PS when it is not performing any operations and is awaiting calls.







◆◆ Signal Search (Cell Search)

You can search for the strongest cell station for your PS while it is in standby mode.

 <p>Press FUNC.</p>	▶	 <p>Press *.</p>	<p><Display></p> <table border="1"><tr><td>SEARCHING</td><td>→</td><td>SEARCH OK</td></tr></table>	SEARCHING	→	SEARCH OK
SEARCHING	→	SEARCH OK				

◆◆ Locking the Keypads

You can lock the dialing buttons while the PS is in idle status.

 <p>Press HOLD for about 2 seconds.</p>	<p><Display></p> <table border="1"><tr><td>To lock</td><td></td></tr><tr><td>HOLD DOWN TO LOCK KEYPAD</td><td>→ </td></tr><tr><td>To unlock</td><td></td></tr><tr><td> →</td><td>HOLD DOWN TO UNLOCK KEYPAD</td></tr></table>	To lock		HOLD DOWN TO LOCK KEYPAD	→ 	To unlock		 →	HOLD DOWN TO UNLOCK KEYPAD
To lock									
HOLD DOWN TO LOCK KEYPAD	→ 								
To unlock									
 →	HOLD DOWN TO UNLOCK KEYPAD								

◆◆ Display

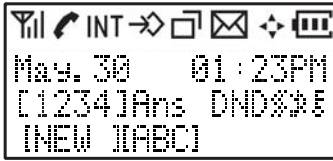

<Radio Signal Strength>

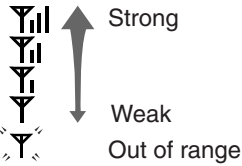

<Off-hook Status>

INT <Off-hook Status for Intercom calls>

<PS Programming Mode>

<Incoming Call Log notification>

<Message Waiting>

When you receive a message while in standby mode, the PS will alert you by vibrating or ringing, depending on the current setting of the Ringer Volume.

<Navigator>

When using the navigator key, only the displayed arrows can be pressed.

<Battery Strength>

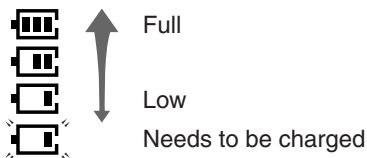

<F-CO Key Display>

The display depends on the operation. (See page 11.)

<Others>

- Ringer ON & Vibration OFF
- Ringer ON & Vibration ON
- Ringer OFF & Vibration ON
- Ringer OFF & Vibration OFF
- Meeting mode
- Call Forwarding
- Do Not Disturb
- Auto Answer mode
- Key Lock

[NEW] [ABC] <Soft Key Display>

The icons displayed above each soft button indicate what functions the soft buttons perform. Functions displayed depend on the state of use. Press the corresponding soft button to select a function.

[NEW] : Used to store a new item in the PS dialing directory.

[ABC] : Displayed when in [ABC] character entry mode, shown in table 1 on page 27. Press to switch to [+ABC] mode.

[+ABC] : Displayed when in [+ABC] character entry mode, shown in table 2 on page 28. Press to switch to [ABC] mode.

[X] : Used to enter an X when storing the "TRUNK ACCESS CD". (See page 39.)

Before Operating the PS

◆◆ Operation Outline

Functions of the PS are accessed through the display menu, and selected with the navigator key and ENTER button.

◆ Navigator key operation

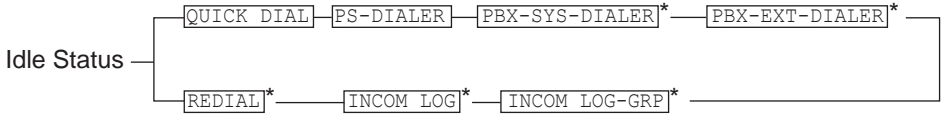

* Displayed only when “” is shown on your PS.

◆ MENU key operation

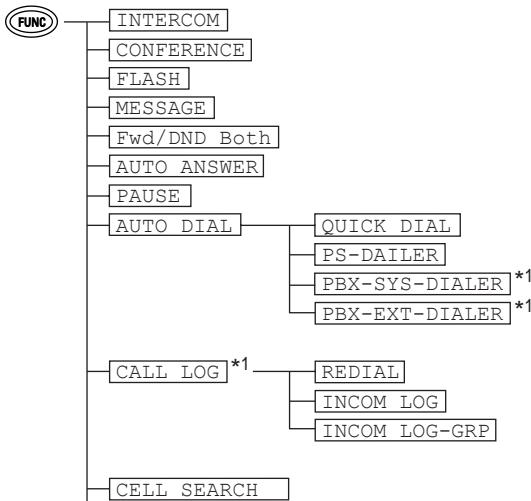

(Continue to the next page.)

Before Operating the PS

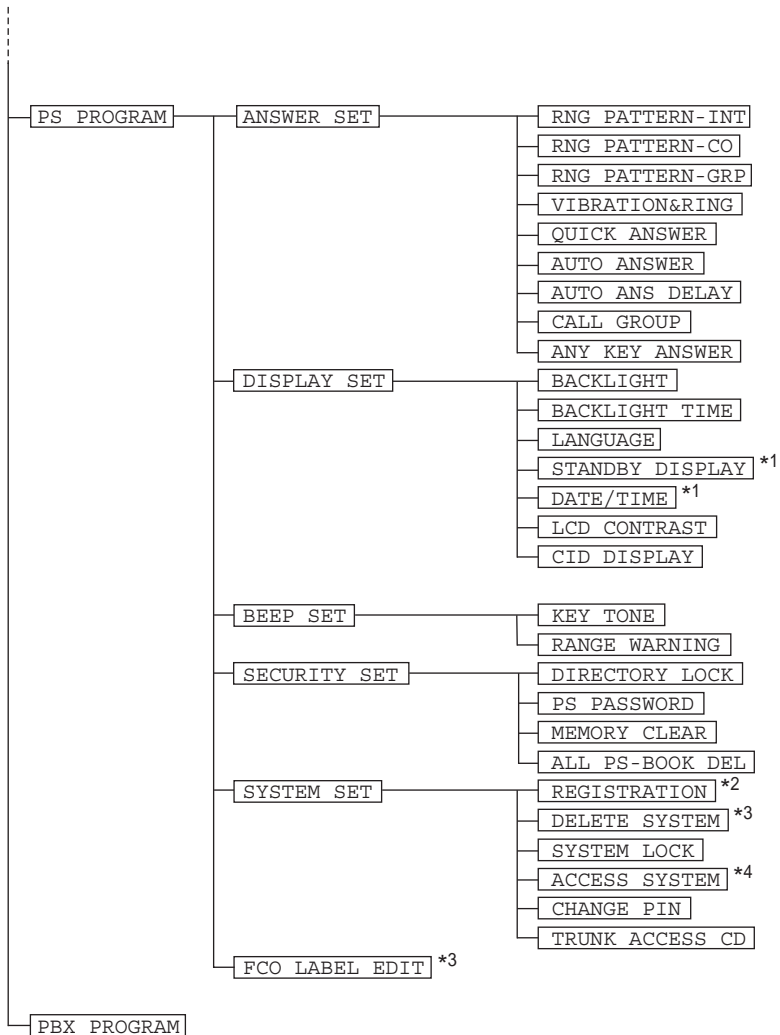

(Refer to the KX-TDA series Business Telephone System User Manual.)



- *1 Displayed only when “” is shown on your PS.
- *2 Not displayed when your PS is registered in four Business Telephone Systems.
- *3 Displayed only when the PS is registered to at least one Business Telephone System.
- *4 Displayed only when the PS is registered to more than one Business Telephone System.



Before Operating the PS

◆◆ Key Operation

The following keys can be activated by a combination of  and a dial button (0-9, *).

Function +	Key	Description
1	INTERCOM	Used to make or receive intercom calls.
2	CONFERENCE	Used to establish a multiple-party conversation.
3	FLASH	Disconnects a current, allowing you to make another call without hanging up.
4	MESSAGE	Used to leave a message to the called party or call back the message sender.
5	Fwd/DND Both	Used to set the Call Forwarding or Do Not Disturb features.
6	AUTO ANSWER	Used to answer an incoming call automatically.
7	PAUSE	Inserts a dialing pause.
8	AUTO DIAL	Used to make a call using the Directories.
9	CALL LOG	Used to make a call using the Call Log.
0	PS PROGRAM	Used to enter the PS Programming mode.
*	CELL SEARCH	Used to search the cell station for your PS while it is in idle status.
	PBX PROGRAM*	Used to enter the PBX Programming mode.



- You can also select a key by pressing , then .
- * In the PBX programming mode, you may change unused F-CO buttons to one touch buttons. For further information, refer to "Customizing the Buttons" in the KX-TDA series Business Telephone System User Manual.

◆◆ Flexible-CO Key Display

The F-CO key can be used to seize an idle outside line while making or receiving an outside call, or used as a feature button. Press the corresponding F-CO button to select the desired flexible CO key. Here you can access the 12 flexible CO keys. Icons shown in the F-CO key function similarly to the light (LED) pattern on a Proprietary Telephone. ◀ ▶ is the same as a green LED, and < > is the same as a red LED.

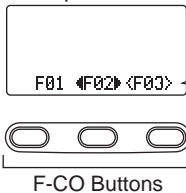

Example:



Understanding the F-CO Key*



◀ ▶	(On): You are currently using this line.
▶◀ ▶◀	(flashing rapidly): You have an incoming call on this line.
▶◀ ▶◀	(flashing slowly): You have a call on hold on this line.
< >	(On): This line is in use by someone else.
>< ><	(flashing rapidly): There is an incoming call received by an incoming call distribution group to which "Ring" is set as the group call distribution method.
>< ><	(flashing slowly): Someone has a call on hold on this line.
(no icon)	(no icon): This line is idle.









- * The icons will be shown only during a conversation or when you press  while in standby mode. The meaning of these icons vary depending on the status of the CO line.
- If no buttons are pressed for 5 seconds after pressing  while in standby mode, the icons disappear.
- For further information, refer to "LED Indication" in the KX-TDA series Business Telephone System Feature Guide.
- Only three F-CO keys can be displayed at once, press  repeatedly to change the F-CO key display (F01-F12).
- The F-CO label can be changed. (See page 40.)



Before Operating the PS

◆◆ Ringer Volume Adjustment



While in standby mode or receiving a call, press  repeatedly. (Default :  high)











Button	Ringer Volume	Display		Icon
		Talk	Hands-free/Monitor	
 ↑ ↓ 	High	RINGER 		
	Medium	RINGER 		
	Low	RINGER 		
	Gradually louder • Low→Medium→High	RINGER STEP UP		
	Gradually quieter • High→Medium→Low	RINGER STEP DOWN		
	Vibration only	VIBRATION ON RINGER OFF		
	• Vibration only • Key tone off • Microphone volume high	MEETING MODE		
	Key tone only	VIBRATION OFF RINGER OFF		



- Press  for about 1 second to change from “MEETING MODE” to “VIBRATION OFF/RINGER OFF”.
- If Key Tone is set to “OFF”, the ring tone does not sound while adjusting the volume. (See page 38.)
- The PS rings for incoming calls while charging (except in “MEETING MODE” and “VIBRATION OFF/RINGER OFF”).
- When pressing  in standby mode to change the current ringer setting, the ringer will not sound. This allows you to turn the ringer off without making any noise.
- The ringer can be set to both vibrate and ring. (See page 34.)

◆◆ Receiver Volume Adjustment

During a conversation or when off-hook, press  repeatedly. (Default :  medium)

Button	Receiver Volume	Display	
		Talk	Hands-free/Monitor
 ↑ ↓ 	Extra High	RECEIVER 	SP-PHONE 
	High	RECEIVER 	SP-PHONE 
	Medium	RECEIVER 	SP-PHONE 
	Low	RECEIVER 	SP-PHONE 

◆◆ Calling Another Extension

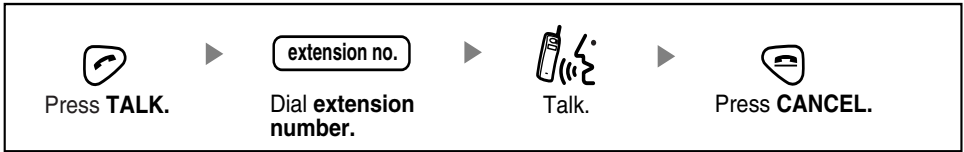





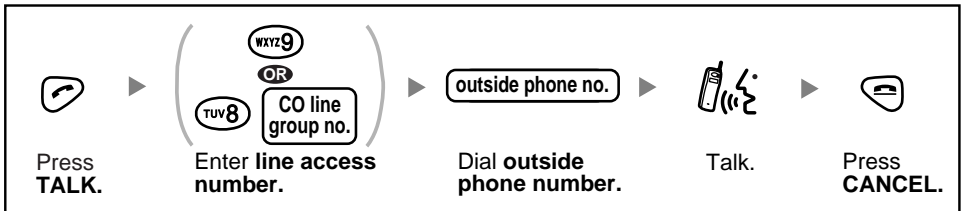

◆◆ Calling an Outside Party

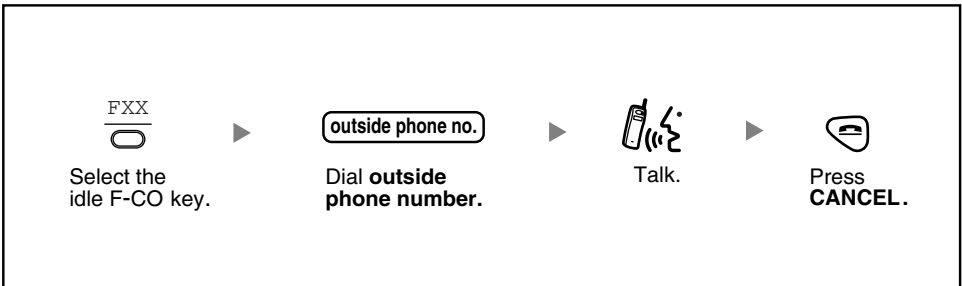
◆ Using the line access numbers





◆ Using Flexible CO keys



- You can confirm a number before calling (**Predialing**) by entering the number, then pressing .
- If you misdial while predialing, press  to highlight the wrong digit and press , then enter the correct digit.
- To clear an entire number while predialing, press and hold .
- If “” flashes, move closer to the Cell Station and try dialing again.
- To cancel dialing, press .

Making Calls

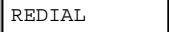
◆◆ Using the Call Log

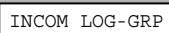
Feature	Display	Description
Outgoing Call Log		You can make a call using the phone numbers you have dialed.
Incoming Call Log		You can make a call using the outside phone numbers you have received.
Incoming Call Log Group		You can make a call using the phone numbers that incoming call distribution groups have received.

◆ Using the outgoing call log

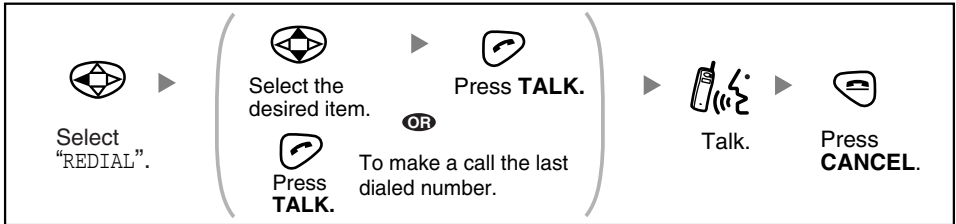

◆ Using the incoming call log



◆ Using the incoming call log group

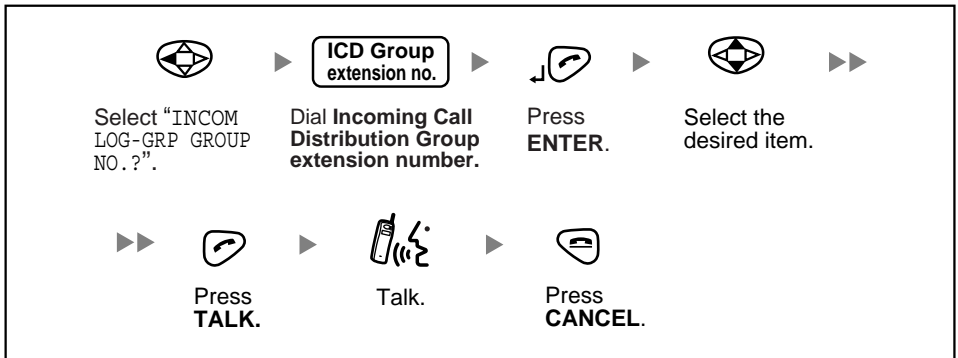

- An outside number stored with a name in the PS dialing directory will be displayed by number and name in the call log.

◆◆ Making Calls Using the Directories

Feature	Display	Description
Quick Dialing	<Example> 1: Tony 1234	You can make a call simply by pressing the preprogrammed number for quick dialing.
PS Dialing Directory	PS-DIALER	You can make a call using the numbers stored in the PS Dialing Directory.
System Speed Dialing Directory	PBX-SYS-DIALER	You can make a call using the numbers stored in the Business Telephone System.
Extension Number Directory	PBX-EXT-DIALER	You can make a call using the extension names stored in the Business Telephone System.

Making Calls

◆ Quick Dialing

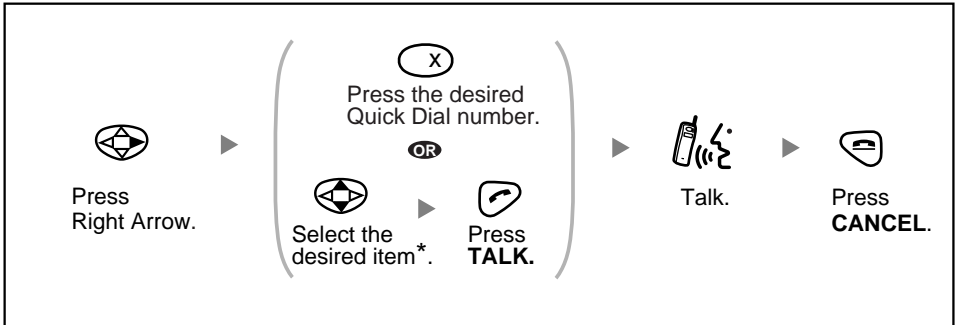

◆ PS Dialing Directory/System Speed Dialing Directory/Extension Number Directory

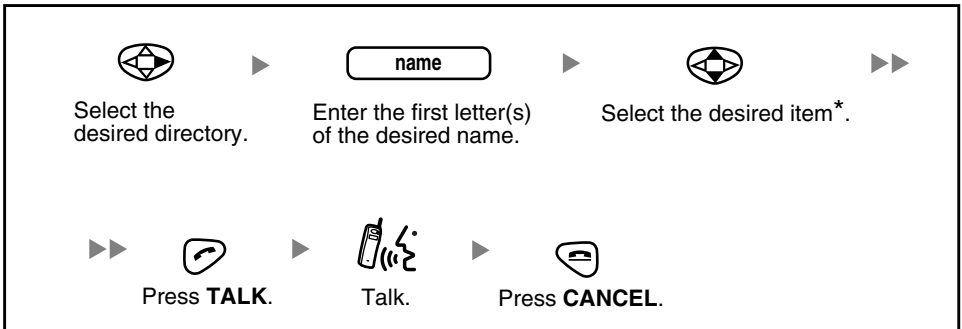

- * You can search for the desired item quickly by pressing and holding  (**Quick Search: used for Quick Dialing and PS Dialing Directory**).
- To enter characters, see pages 27 and 28.
- You can also store names and phone numbers for Quick Dialing. (See page 21.)

◆◆ Intercom Calls/Outside Calls/Group Calls

While receiving a call

Intercom Calls/Outside Calls/Group Calls

To answer a call when the PS is ringing



Intercom Calls

To answer a call on a specific line

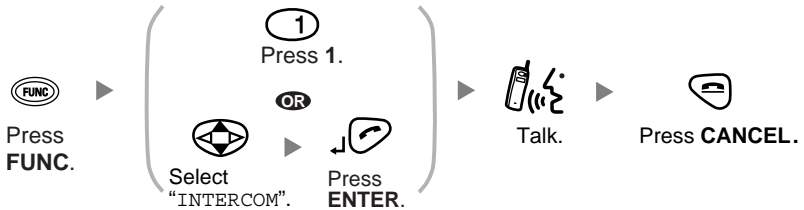

Outside Calls

To answer a call on a specific line



- You can also answer a call as follows:
 - Any Key Answer** (See page 36.)
 - Auto Answer** (See page 34.)
 - Quick Answer** (See page 34.)
- When you receive an outside call, the caller's information is recorded automatically in the incoming call log even when the PS is off-hook, out of range, or when the nearest Cell Station is busy.

Receiving Calls

Incoming Call Notification

- You can select a different Ringer and Vibration pattern for each type of incoming call:

Incoming Call Status	LED Indication	Ringer Pattern	Vibration Pattern
Intercom call	flashing green	6 ringer tones, 4 melodies (See page 34.)	3 patterns (See page 34.)
Outside line call	flashing red		
Group call*	flashing orange		

* Group calls are calls received by a PS extension which is assigned to a:

- PS ring group
- Incoming Call Distribution Group in which “Ring” is set as the group call distribution method

Caller ID Display

- If an incoming call contains Caller ID information (the caller’s name and number), the caller can be displayed on the PS in one of the two following ways.
 - If the caller’s information is stored in the Business Telephone System, that information can be displayed.
 - If the caller’s information is stored in the PS, that information can be displayed.
- If information is stored in both the system and in the PS for the same caller, you can choose which information will be displayed on the PS. The default setting displays caller information stored in the system. (See page 38.) When receiving a call, you can toggle between the two settings by pressing **Ⓢ**.
To display caller information, a line access number must be stored. (See “TRUNK ACCESS CD” on page 39.)
- To display caller information stored in the PS directory, an outside line number must be stored with the caller’s phone number, and the phone number must only contain digits (0-9).

Incoming Call Identification

- Items stored in the PS dialing directory can be organized into one of 10 groups. A call from someone stored in one of these groups will be indicated by the pattern of ringer, LED and vibration for the group. (See page 35.)

Item	Setting
RING PATTERN	6 ringer tones, 4 melodies (See page 35.)
LED PATTERN	9 patterns (See page 35.)
VIB PATTERN	5 patterns (See page 35.)

◆◆ Transferring a Call

◆ Transferring to an extension

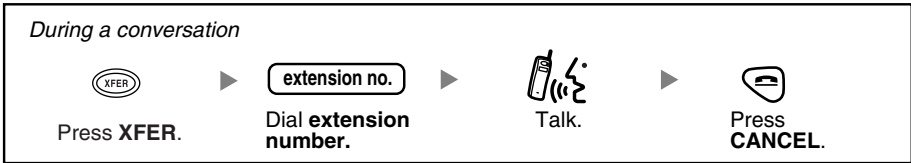

◆ Transferring to an outside party

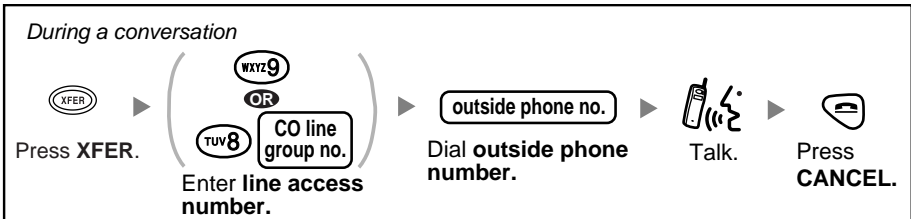

- To return to the call before the destination answers, press **XFER CLR** or select the “INTERCOM” key/the corresponding CO key.

◆◆ Holding

◆ To hold (Regular Hold)

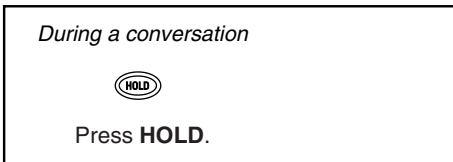

◆ To hold (Exclusive Call Hold)

You can hold a call exclusively so that other people cannot retrieve the call.



- The operation depends on the Call Hold mode (Regular Hold/Exclusive Call Hold). Ask your manager what the current mode is.
- When you hold several outside line calls, assign the CO buttons (S-CO/G-CO/L-CO/GDN) as necessary, beforehand.

During a Conversation

◆ To retrieve a call

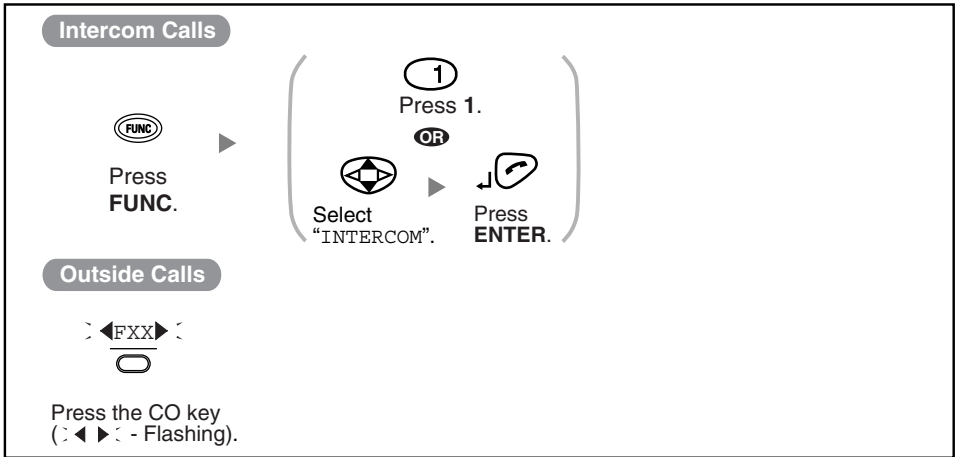

◆◆ Hands-free/Monitor Conversation

Feature	Display	Description
Hands-free*	HANDS FREE	You can talk with the calling party alternately through the speaker without holding the PS.
Monitor	MONITOR MODE	You can listen to the calling party's voice through the speaker without holding the PS. Your voice will not be heard.

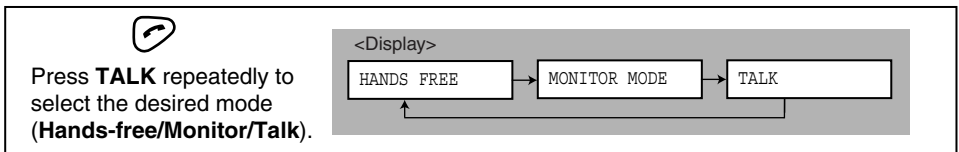

- * For best performance in hands-free mode, please note the followings:
 - Talk alternately with the other party in a quiet room.
 - If you or the other party has hearing difficulty, press  to decrease the speaker volume.
- The receiver volume level can be adjusted separately. (See page 12.)
- If you connect a headset while in hands-free/monitor conversation, the mode will be canceled automatically.
- If you put the PS on the charger during a conversation, the call will be disconnected, except when having a hands-free or monitor call.

◆◆ Directories

Feature	Display	Description
Quick Dialing	<Example> 1: Tony 1234	You can store names and phone numbers, as well as system feature names and numbers for easy access. (Max. 10 items.)
PS Dialing Directory	PS-DIALER	You can store up to 100 names, phone numbers and group numbers in the PS. If you store an outside party's number, you should first store a line access number. All directory items are stored in alphabetical order.

◆◆ Quick Dialing



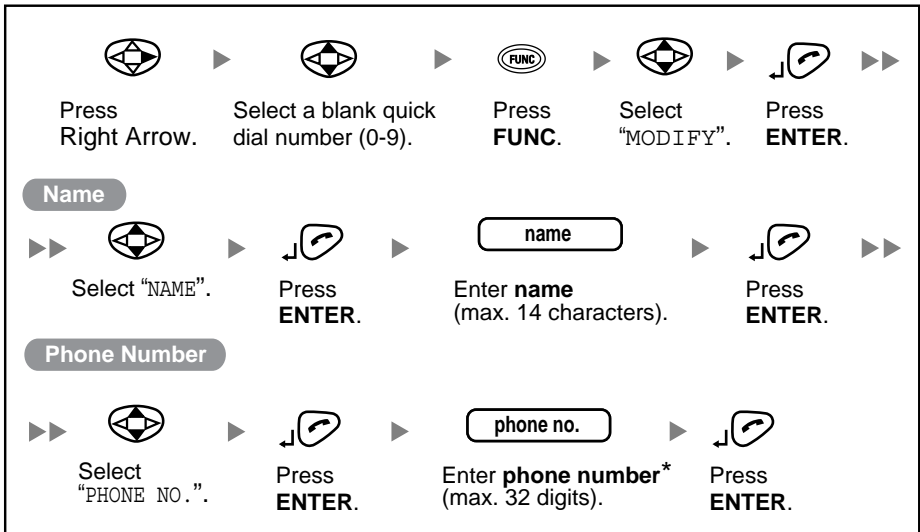

◆ Storing



- To enter characters, refer to page 27 and 28.
- * The valid digits are "0" through "9", "*", "#", PAUSE and "X" (INTERCOM). The "X" can be entered numbers you want when dialing.





Using the Directories

◆ Editing

 →  →  →  →  →



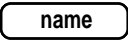

Press Right Arrow. Select the desired item. Press **FUNC**. Select "MODIFY". Press **ENTER**.

Name

→  →  →  →  →



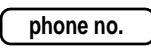

Select the name. Press **ENTER**. Edit the **name** (max. 14 characters). Press **ENTER**.

Phone Number

→  →  →  →  →





Select the phone number. Press **ENTER**. Edit the **phone number*** (max. 32 digits). Press **ENTER**.





- To enter characters, refer to pages 27 and 28.
- * The valid digits are "0" through "9", "*", "#", PAUSE and "X" (INTERCOM). The "X" can be entered numbers you want when dialing.
- To change a character or digit, press  to highlight it, press  to delete it, then enter the new character or digit.
- To clear an entire line, press and hold .
- To move the cursor to the left or right, press  or , respectively.

◆ Deleting

Deleting an Item







 →  →  →  →  →

Press Right Arrow. Select the desired item. Press **FUNC**. Select "DELETE". Press **ENTER**.

→  →  →

Select "YES". Press **ENTER**.

Deleting All Items

 →  →  →  →  →  →

Press Right Arrow. Press **FUNC**. Select "DELETE ALL". Press **ENTER**. Select "YES". Press **ENTER**.

◆◆ PS Dialing Directory

◆ Storing

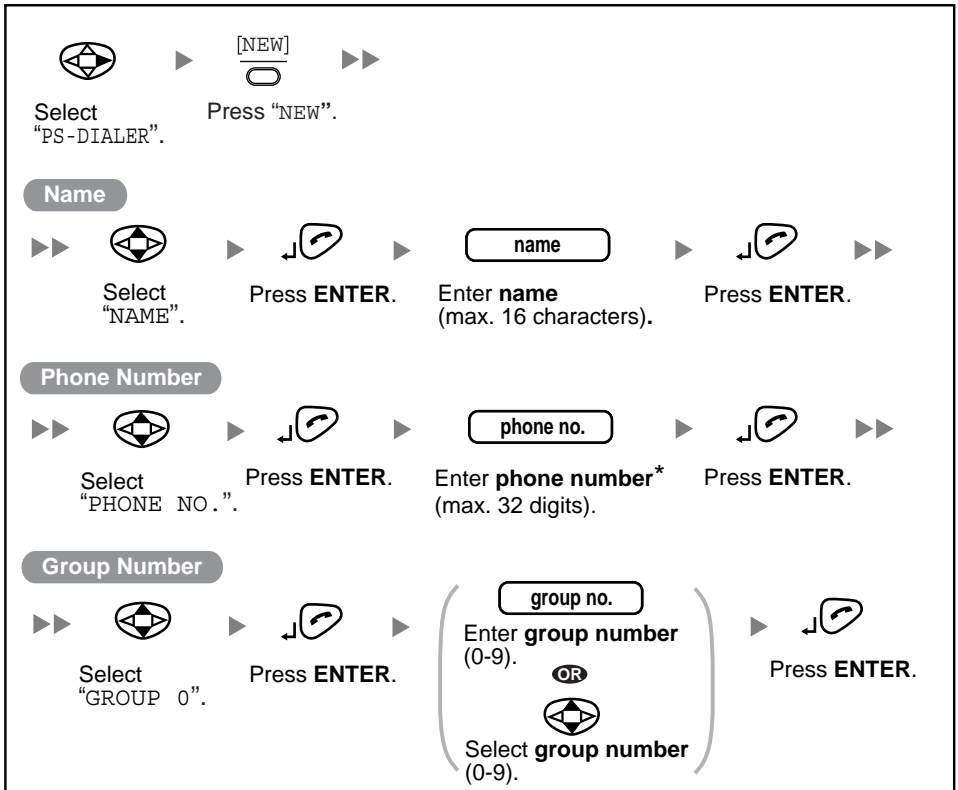

- To enter characters, refer to pages 27 and 28.
- * The valid digits are "0" through "9", "*", "#", PAUSE.
- If you store an outside phone number, you should first store a line access number in front of the phone number.

Using the Directories

◆ Editing

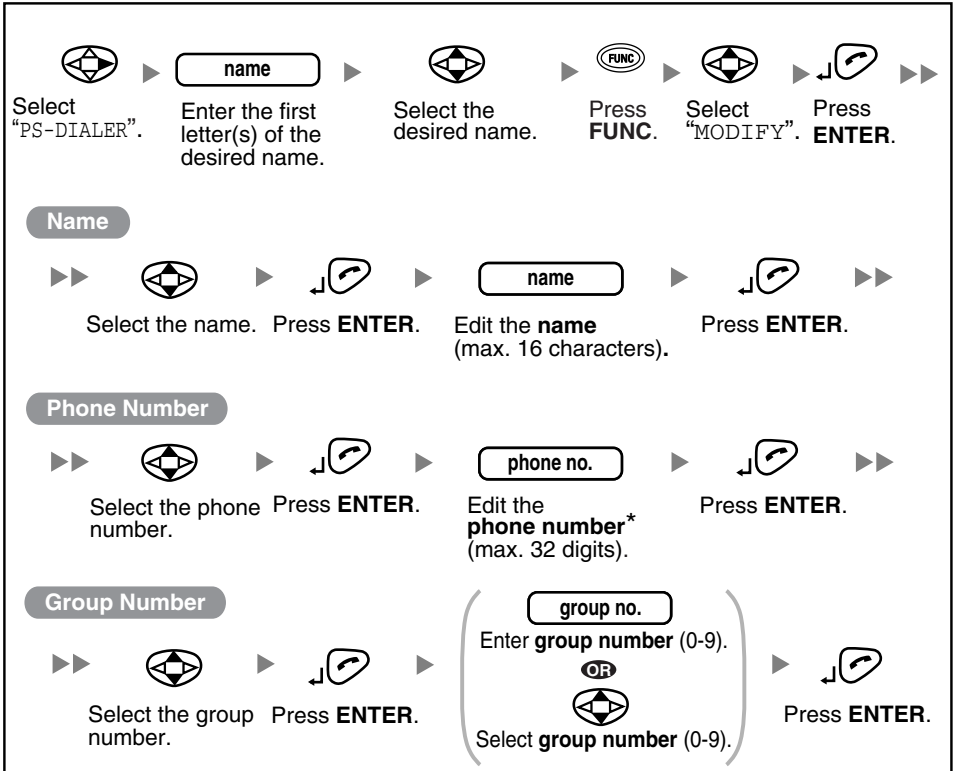

- To enter characters, refer to pages 27 and 28.
- * The valid digits are "0" through "9", "*", "#", PAUSE.
- To change a character or digit, press to highlight it, press to delete it, then enter the new character or digit.
- To clear an entire line, press and hold .
- To move the cursor to the left or right, press or , respectively.

◆ Deleting

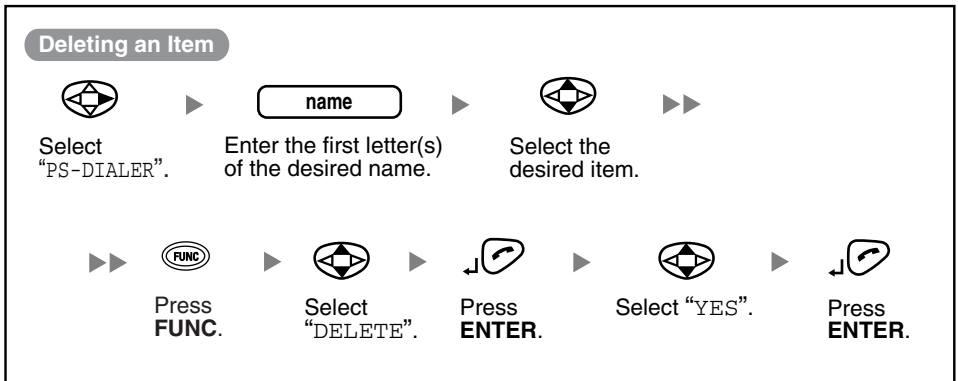

- You can delete all items at once. (See page 39.)

Using the Directories

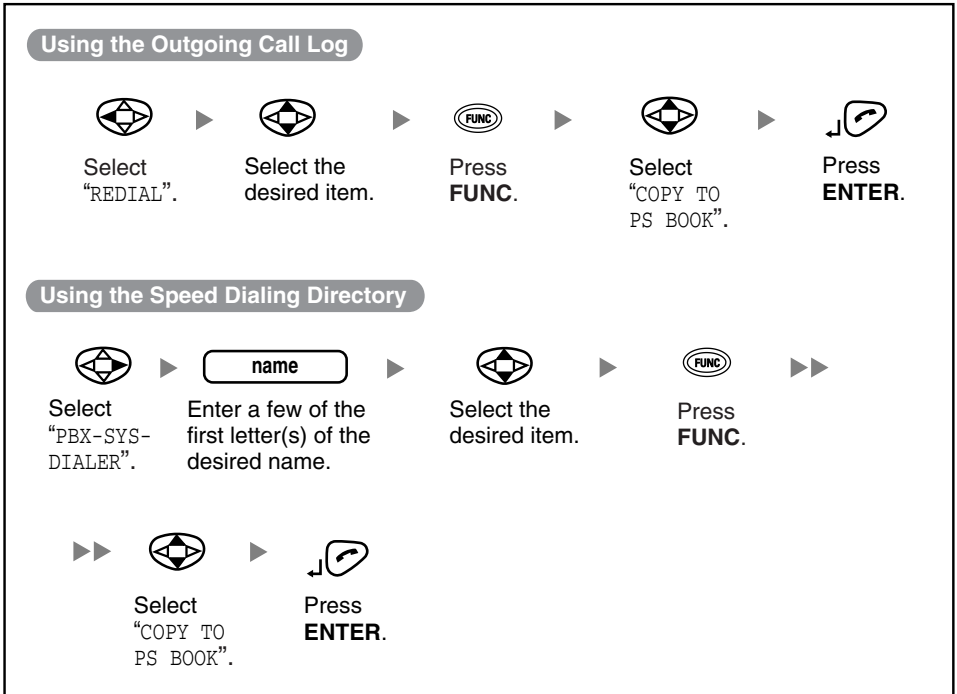

◆ Storing an item for PS Dialing Directory



- When storing an outside phone number, the line access number will be stored automatically. The line access number must be identical to the PS's "TRUNK ACCESS CD" setting (SYSTEM SET). (See page 39.)

◆◆ Entering Characters





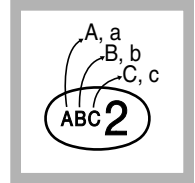







You can enter characters and digits using the dialing buttons. Pressing a dialing button repeatedly displays different characters as shown in the following tables.

To toggle between the two tables, press  or  at any time while you are entering characters.











◆ Character mode table

Table 1 (ABC)

Times Buttons	1	2	3	4	5	6	7	8	9
	!	?	"	1					
	A	B	C	a	b	c	2		
	D	E	F	d	e	f	3		
	G	H	I	g	h	i	4		
	J	K	L	j	k	l	5		
	M	N	O	m	n	o	6		
	P	Q	R	S	p	q	r	s	7
	T	U	V	t	u	v	8		
	W	X	Y	Z	w	x	y	z	9
	(space)	.	,	'	:	;	0		
	/	+	-	=	<	>	*		
	\$	%	&	@	()	€	£	#

For example, to enter “Anne”:

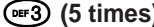





			
	 (5 times)	 ►  (5 times)	 (5 times)

Using the Directories

Table 2 (+ÄÖÜ)

Times Buttons	1	2	3	4	5	6	7	8	9	10	11	12	13	14	15
1	!	?	"	ä	ö	ü	1								
2	A	B	C	a	b	c	À	Á	Â	Ã	Ä	Å	Æ	Ç	2
3	D	E	F	d	e	f	Ð	È	É	Ê	Ë	3			
4	G	H	I	g	h	i	Ì	Í	Î	Ï	4				
5	J	K	L	j	k	l	5								
6	M	N	O	m	n	o	Ñ	Ò	Ó	Ô	Õ	Ö	Ø	Œ	6
7	P	Q	R	S	p	q	r	s	ß	7					
8	T	U	V	t	u	v	Ù	Ú	Û	Ü	8				
9	W	X	Y	Z	w	x	y	z	Ý	9					
0	(space)	.	,	'	:	;	0								
*	/	+	-	=	<	>	*								
#	\$	%	&	@	()	€	£	#						











- To enter a character located on the same dialing button as the previous character, move the cursor by pressing , then enter the desired character .
- If you enter a different character by mistake, press  to highlight the character, press  to delete it, then enter the correct character.
- To clear an entire line, press and hold .
- To move the cursor to the left or right, press  or , respectively.













































Other Operations

C. Tone: Confirmation Tone D. Tone: Dial Tone R.B. Tone: Ringback Tone
 ICD Group: Incoming Call Distribution Group PIN: Personal Identification Number







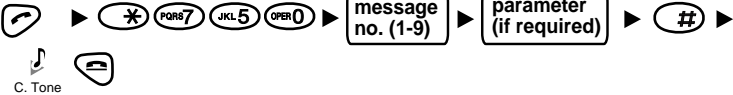

Feature	Operation				
Making Calls					
One-touch Dialing	To dial ▶ Select the F-CO key assigned as a One-touch Dialing button. ▶				
	To store ▶ Select "PBX PROGRAM". ▶ ▶ Select a desired F-CO Key. ▶ ▶ ▶ ▶				
Hot Line	To store ▶ ▶ ▶				
	To set/cancel ▶ ▶ <table border="1" style="display: inline-table; vertical-align: middle;"><tr><td>1</td><td>Set</td></tr><tr><td>OPER0</td><td>Cancel</td></tr></table>	1	Set	OPER0	Cancel
	1	Set			
OPER0	Cancel				
To dial 					
Operator Call	▶ ▶				
System Speed Dialing	To dial ▶ ▶ ▶				
Doorphone Call	▶ ▶				
Automatic Callback Busy	To set <i>While hearing a busy tone</i> 				
	To cancel ▶				
	To answer from an idle extension <i>While hearing a callback ring</i> 				
	To answer from an idle outside line <i>While hearing a callback ring</i> ▶ ▶				

Other Operations

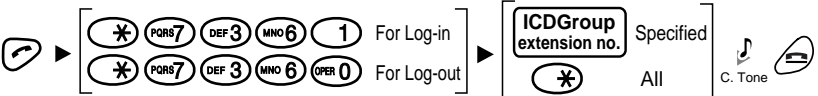
Feature	Operation
During a Conversation	
Multiple Party Conversation	<p>To add other parties during a conversation</p>  <p>Talk to the new party.</p>  <p>Talk with multiple parties.</p>
	<p>To leave a conference</p> 
Useful Features	
Call Forwarding	 <div style="display: inline-block; border: 1px solid black; padding: 5px; margin-left: 10px;"> <p>OPER 0 Both Calls</p> <p>1 Outside Calls</p> <p>ABC 2 Intercom Calls</p> </div> <div style="display: inline-block; border: 1px dashed black; padding: 10px; margin-left: 20px;"> <p>ABC 2 All calls</p> <p>DEF 3 Busy</p> <p>GHI 4 No answer</p> <p>JKL 5 Busy/No answer</p> <p>OPER 0 Cancel</p> <p>PQRS 7 Follow Me</p> <p>TUV 8 Cancel Follow Me</p> </div> <div style="display: inline-block; border: 1px solid black; padding: 5px; margin-left: 10px;"> <p>extension no.</p> <p>OR</p> <p>CO line access no. → outside phone no.</p> </div> <p>→ #  </p> <div style="display: inline-block; border: 1px solid black; padding: 5px; margin-left: 20px;"> <p>your extension no.</p> </div>
Do Not Disturb	 <div style="display: inline-block; border: 1px solid black; padding: 5px; margin-left: 10px;"> <p>OPER 0 Both Calls</p> <p>1 Outside Calls</p> <p>ABC 2 Intercom Calls</p> </div> <div style="display: inline-block; border: 1px solid black; padding: 5px; margin-left: 10px;"> <p>1 Set</p> <p>OPER 0 Cancel</p> </div> <p>→  </p>

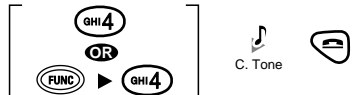
Feature	Operation
Useful Features	
Call Pickup	 <div style="border: 1px dashed black; padding: 5px; display: inline-block;"> <p>Directed</p> <p>   ► extension no.</p> <p>Group</p> <p>   ► group no. (2digits)</p> </div> <div style="display: inline-block; vertical-align: middle; margin-left: 20px;">   </div>
Sending a Call Waiting Tone	<p><i>While hearing a busy tone</i></p>  ► Wait for an answer. ► 
Call Waiting	<p>To set/cancel for intercom calls</p>  ►     ►  No call  Tone <div style="display: inline-block; vertical-align: middle; margin-left: 20px;">   </div>
	<p>To set/cancel for outside calls</p>  ►     ►  No tone  Tone <div style="display: inline-block; vertical-align: middle; margin-left: 20px;">   </div>
	<p>To talk to the second party <i>While hearing a tone</i></p> <div style="display: flex; align-items: center;">  ► Select the F-CO key. OR  ► Select "INTERCOM". (Disregard this step if both parties are extensions.)  </div>
Paging	<p>To page</p>  ►    ► paging group no. (2 digits) <div style="display: inline-block; vertical-align: middle; margin-left: 20px;">   ► Announce. </div> <p>► Wait for an answer. ► </p>
	<p>To answer</p>  ►    <div style="display: inline-block; vertical-align: middle; margin-left: 20px;">   </div>

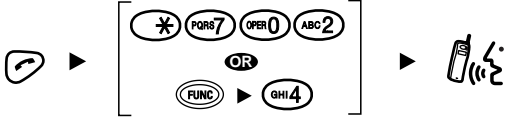
Other Operations

Feature	Operation	
Useful Features		
Absent Message	<p>To set</p> 	
	<p>To cancel</p> 	
Log-in/ Log-out		
Extension Setting Clear		
Message Waiting	Caller	<p>To leave a message waiting indication <i>When the called extension is busy or does not answer</i></p> 
		<p>To cancel a message waiting indication</p> 
	Called extension	<p>To call back</p> 
Extension Lock*	<p>To lock</p> 	
	<p>To unlock</p> 	



- * If an extension PIN has not been set for the PS, the extension cannot be locked. (Refer to the Business Telephone System User Manual)
- For further information, refer to the Business Telephone System User Manual.

◆◆ Changing the Initial Settings

You can customize the PS by editing the settings found under “PS PROGRAM” in the menu list, as follows:

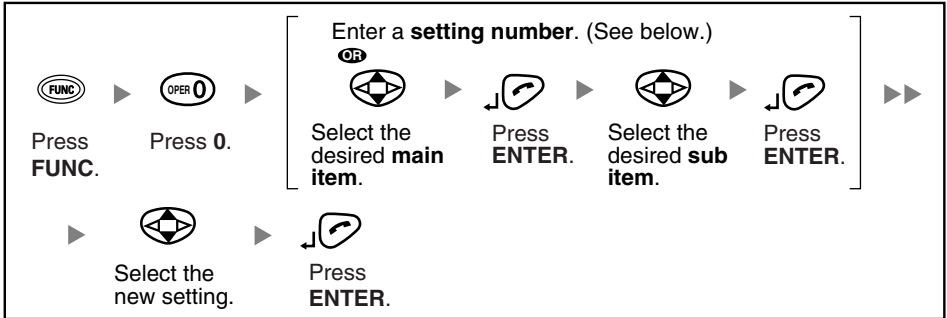

- To return to the previous menu, press .
- To cancel, press at any time.
- The unit will beep to indicate that the new settings have been saved.

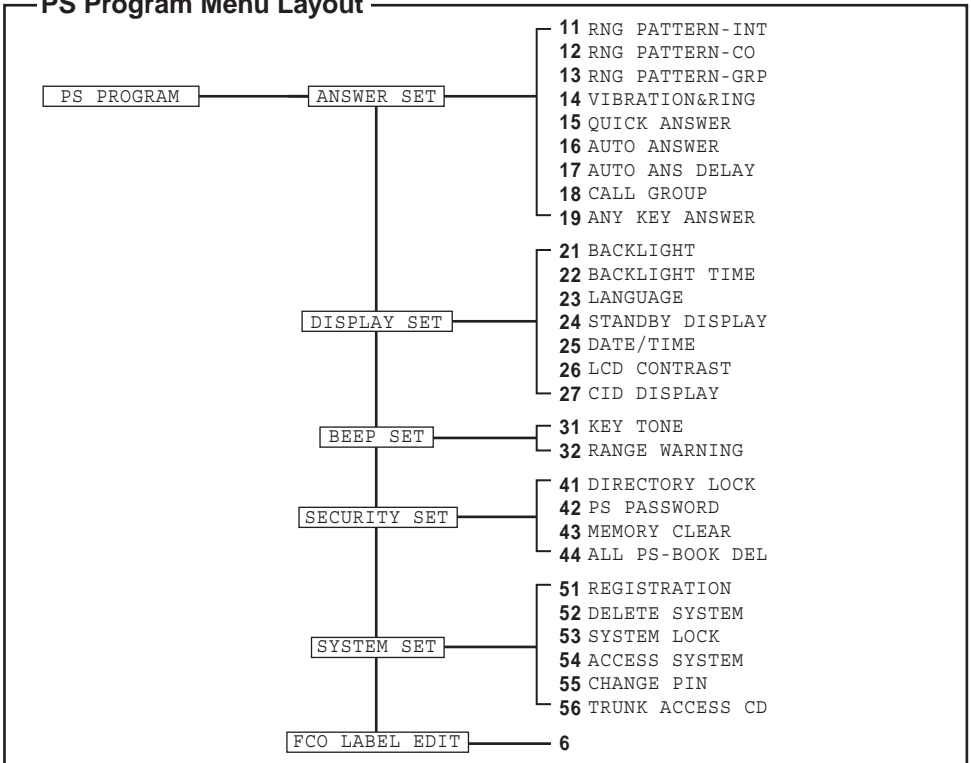

PS Program Menu Layout



Programming

Main Item	Sub Item	Description	Setting*	Setting no.
ANSWER SET	RNG PATTERN-INT	Select the ringer type for each type of call (intercom, outside, and group). 6 ringer tones and 4 melodies are available.	<input type="checkbox"/> Ringer Pattern no.	11
	RNG PATTERN-CO		<input type="checkbox"/> Ringer Pattern 1 (Bell 1)	12
	RNG PATTERN-GRP			13
	VIBRATION&RING	Select whether to have the PS vibrate when ringing.	<input type="checkbox"/> OFF	14
			<input type="checkbox"/> Ring&VIB (Ring and vibrate at the same time)	
			<input type="checkbox"/> VIB→RING (Vibrate for 5 seconds then ring)	
	QUICK ANSWER	You can answer a call by just lifting the PS off the charger.	<input type="checkbox"/> ON	15
<input type="checkbox"/> OFF				
AUTO ANSWER	Select the type of calls to be automatically answered when AUTO ANSWER is turned on. (See page 10.)	<input type="checkbox"/> INT ONLY (Intercom calls only)	16	
		<input type="checkbox"/> INT/CO (All calls)		

* The default setting is shown here in gray.

Main Item	Sub Item	Description	Setting*	Setting no.
ANSWER SET	AUTO ANS DELAY	Select the number of seconds (6-20 sec.) before a call is automatically answered, when AUTO ANSWER is turned on.	<input type="checkbox"/> 6 s	17
			<input type="checkbox"/> _ s	
	CALL GROUP	You can set the ringer, LED, and vibration for calls from someone stored in one of groups. A group's settings can also be returned to the default. Press  to select a group, then press  . The following four items will be displayed.	<input type="checkbox"/> Select a group (0-9)	18
	RING PATTERN	Select a ring pattern for the group selected above. When set to CO/GRP-PATTERN, the ringer chosen in RING PATTERN-CO (setting number 12) will be used.	<input type="checkbox"/> CO/GRP-PATTERN	
			<input type="checkbox"/> Ringer Pattern no.	
	LED PATTERN	Select an LED pattern for the group selected above. When set to CO/GRP-BLINK, the LED will light as shown on page 18.	<input type="checkbox"/> CO/GRP-BLINK	
			<input type="checkbox"/> LED Pattern no.	
	VIB PATTERN	Select a vibration pattern for the group selected above.	<input type="checkbox"/> SINGLE	
		<input type="checkbox"/> Vibration Pattern no.		
	DEFAULT SETTING	Returns the ringer, LED, and vibration settings for the group selected above to the default settings.	<input type="checkbox"/> NO	
			<input type="checkbox"/> YES	

* The default setting is shown here in gray.

Programming

Main Item	Sub Item	Description	Setting*	Setting no.
ANSWER SET	ANY KEY ANSWER	When set to ON, allows you to answer a call by pressing any dial button (0-9,*,#).	<input type="checkbox"/> ON <input checked="" type="checkbox"/> OFF	19
DISPLAY SET	BACKLIGHT	Select whether or not the keypad and display backlight will illuminate when a key is pressed or a call is received. Select "IN-RECEIVING" to have the dial buttons and backlight illuminate only when a call is received.	<input checked="" type="checkbox"/> ON	21
			<input type="checkbox"/> IN-RECEIVING <input type="checkbox"/> OFF	
	BACKLIGHT TIME	Select how many seconds the keypad and display backlight will remain illuminated.	<input checked="" type="checkbox"/> 5 s <input type="checkbox"/> 10 s <input type="checkbox"/> 15 s <input type="checkbox"/> 20 s <input type="checkbox"/> 25 s <input type="checkbox"/> 30 s	22
LANGUAGE		Select which language your PS will display. When set to AUTO, the language settings of the Business Telephone System will be used.	<input checked="" type="checkbox"/> AUTO	23
			<input type="checkbox"/> ENGLISH	
			<input type="checkbox"/> ESPANOL	
			<input type="checkbox"/> FRANCAIS	

* The default setting is shown here in gray.

Main Item	Sub Item	Description	Setting*	Setting no.
DISPLAY SET	STANDBY DISPLAY	Select whether the PS will show its extension number or the system number on the display when in standby mode. You can also choose to display neither.	<input type="checkbox"/> EXTN (Extension no.)	24
			<input type="checkbox"/> SYS-NO. (PBX no.)	
			<input type="checkbox"/> OFF	
DATE/TIME		Select the format for the date shown on the display in standby mode.	<input type="checkbox"/> DATE-MM/DD 12H	25
			<input type="checkbox"/> DATE-MM/DD 24H	
			<input type="checkbox"/> DATE-MM/DD/YY	
			<input type="checkbox"/> DATE-DD/MM 12H	
			<input type="checkbox"/> DATE-DD/MM 24H	
			<input type="checkbox"/> DATE-DD/MM/YY	
LCD CONTRAST		Select one of 12 levels of contrast for the display.	<input type="checkbox"/> LEVEL _	26
			<input type="checkbox"/> LEVEL 6	

* The default setting is shown here in gray.

Programming

Main Item	Sub Item	Description	Setting* ¹	Setting no.
DISPLAY SET	CID DISPLAY	Select which caller information is displayed. Either the information stored in the system, or the information stored in the PS dialing directory can be displayed.	<input type="checkbox"/> PBX SETTING	27
			<input type="checkbox"/> PS Dialing DIRECTORY	
BEEP SET	KEY TONE	Turn the key tone on or off.	<input type="checkbox"/> ON	31
			<input type="checkbox"/> OFF	
	RANGE WARNING	Turn the range warning alarm on or off.	<input type="checkbox"/> ON	32
			<input type="checkbox"/> OFF	
SECURITY SET	DIRECTORY LOCK	Select whether to lock the PS dialing directory, Incoming Call Log, Incoming Call Log Group, and Outgoing Call Log, or not. If you have not enabled PS PASSWORD (setting number 42), you will be asked to set a password here when setting the lock to ON. In this case, PS PASSWORD is automatically set to ENABLE, using the password you entered here.* ²	<input type="checkbox"/> ON	41
			<input type="checkbox"/> OFF	
	PS PASSWORD	Select whether to password protect your DIRECTORY LOCK, MEMORY CLEAR, and ALL PS-BOOK DEL settings.* ² When disabling this setting, DIRECTORY LOCK (see above) is automatically turned off.	<input type="checkbox"/> ENABLE	42
			<input type="checkbox"/> DISABLE	

*¹ The default setting is shown here in gray.

*² Once you have set a password, the PS cannot reveal it to you. Write down your password and keep it somewhere safe.





Main Item	Sub Item	Description	Setting*1	Setting no.
SECURITY SET	MEMORY CLEAR	Select YES to return the following to their default settings: -ANSWER SET (except CALL GROUP) -DISPLAY SET -BEEP SET -SECURITY SET (except PS PASSWORD, MEMORY CLEAR, ALL PS-BOOK DEL) -RINGER/RECEIVER VOLUME	<input type="checkbox"/> NO <input type="checkbox"/> YES	43
	ALL PS-BOOK DEL	Select YES to delete all items stored in the PS dialing directory.	<input type="checkbox"/> NO <input type="checkbox"/> YES	44
SYSTEM SET	REGISTRATION	Consult your dealer for details.		51
	DELETE SYSTEM	You can delete the stored system in the PS. Consult your dealer for details.	<input type="checkbox"/> SYSTEM 1-4 <input type="checkbox"/> NO <input type="checkbox"/> YES	52
	SYSTEM LOCK	Select ENABLE to password protect the settings under SYSTEM SET. Note: this password is not the same as the one set under PS PASSWORD.	<input type="checkbox"/> ENABLE <input checked="" type="checkbox"/> DISABLE	53
	ACCESS SYSTEM	Select which system the PS will access, if registered to more than one Business Telephone System.*2	<input checked="" type="checkbox"/> AUTO <input type="checkbox"/> SYSTEM 1-4*2	54
	CHANGE PIN	Before registering your PS with a Business Telephone System, enter the system's PIN here. Once you have registered the PS with a system, this PIN can be changed so that the PS can be registered to an additional system.	<input type="checkbox"/> PIN no.	55
	TRUNK ACCESS CD	Enter the trunk access code (line access number) that matches the settings of your Business Telephone System.	<input type="checkbox"/> 9 <input checked="" type="checkbox"/> 8XX*3 <input type="checkbox"/> NONE	56

*1 The default setting is shown here in gray.

*2 Only systems to which the PS is registered are displayed.



*3 XX is identical to the CO line group no. and 8XX represents any 3-digit code starting with "8".

Programming



Main Item	Sub Item	Description	Setting	Setting no.
FCO LABEL EDIT		<p>You can edit the F-CO label.</p> <p>To edit:</p> <ol style="list-style-type: none">1. Press  to select the desired system or enter the system number (1-4)*.2. Press .3. Press  to select the desired F-CO key or enter the F-CO number (0-9, *, #).4. Press .5. Edit the label (max. 3 characters).6. Press .		6

* Only systems to which the PS is registered are displayed.

◆◆ Troubleshooting for Portable Station

Problem	Description and Solution
<p>The PS does not work.</p>	<ul style="list-style-type: none"> • The battery is drained. → Charge the battery fully. (See “Charging” on page 5.) • The PS has been canceled or the PS has not been registered. → Consult your dealer. • The power is OFF. → Turn it ON. (See “Power On/Off” on page 6.)
<p>The PS does not ring.</p>	<ul style="list-style-type: none"> • Ringer volume is set to “VIBRATION ON/RINGER OFF”, “MEETING MODE” or “VIBRATION OFF/RINGER OFF”. → Set to ring by pressing . (See “Ringer Volume Adjustment” on page 12.)
<p>You cannot make/receive a call.</p>	<ul style="list-style-type: none"> • The PS is out of range or the Cell Station (CS) is busy. → Move closer to the CS or try again later. • The radio channel is busy or a radio communication error occurred. → Try again later.
<p>You cannot dial.</p>	<ul style="list-style-type: none"> • The number which you dialed is restricted by the Business Telephone System. → Consult your dealer. • The key lock mode is set. → To cancel the mode, depress  for about 2 seconds. (See “Locking the Keypads” on page 6.) • The radio channel is busy or a radio communication error occurred. → Try again later.
<p>Noise is frequently caused.</p>	<p>→ Set the PS and CS away from other electrical appliances. → Move closer to the CS.</p>
<p>“CS BUSY” is displayed.</p>	<ul style="list-style-type: none"> • When the Cell Station is busy, the PS will sound a search tone. If the PS does not find an available Cell Station, a busy tone will be heard. → Try again later.
<p>“NEED REPAIR 1(-3)” is displayed.</p>	<p>→ Consult your dealer.</p>
<p>“PS Not Connected” is displayed.</p>	<ul style="list-style-type: none"> • The called PS is out of range or the PS is power off. → Wait until the called PS moves closer to the CS, and try again.

Troubleshooting

Problem	Description and Solution
<p>“NO SERVICE” is displayed.</p>	<ul style="list-style-type: none"> • The PS is out of range. → Move closer to the CS.
<p>The alarm sounds after pressing the Redial button.</p>	<ul style="list-style-type: none"> • The Call Log contains no entries.
<p>The PS stops working during operation.</p>	<p>→ Turn the power OFF and ON. Then try again. (See “Power On/Off” on page 6.)</p> <p>→ Re-insert the battery and try again. (See “Setting Up” on page 5.)</p>
<p>The display does not show a strong radio signal “ <ul style="list-style-type: none"> • Obstacles (such as walls or partitions) are interfering with the radio waves sent between the PS and the CS. • The nearest CS may be occupied, and as a result the PS may be linked to a CS that is further away. • In general, the PS can be used when signal strength is “ <p>The alarm sounds during a conversation while receiving a weak radio signal “ <ul style="list-style-type: none"> • The radio signal is weak. → Move closer to the CS. </p></p>	

Battery Information

After your Panasonic battery is fully charged [at 25 °C (77 °F)]:

Operation	Approx. battery charge
While in use (Talk)	Up to about 8 hours
While not in use (Stand-by)	Up to about 120 hours

- Battery charge may be shortened depending on usage conditions and ambient temperature.
- The battery cannot be overcharged.
- The battery will drain even while the unit is “OFF”.
- The Portable Station (PS) can receive calls while charging.
- Battery consumption increases when the PS is used out of range. If “” flashes, power off the PS.

Low Battery Warning

The battery needs to be charged in the following situations:

- “” flashes or the alarm sounds every five seconds*.
- When “CHARGE BATTERY” is displayed, charge your PS for 7 hours. When “CHARGE BATTERY” is displayed, the PS cannot be operated.

* If the low battery warning occurs during a conversation, you can continue for another minute, and then the call will be disconnected automatically.

Replacing the Batteries

If “” flashes after a few telephone calls even when the batteries have been fully charged, it is time to replace the batteries with new ones.

Before replacing the batteries, make sure the low battery warning is displayed, then turn off the power to prevent memory loss. Replace the batteries. Charge the new batteries for at least 7 hours. If you replace the batteries before the low battery warning appears, the battery strength icon may display an incorrect reading. In this case, use the PS as normal with the new batteries installed. When the low battery warning is displayed, charge the batteries for about 7 hours. The battery strength icon will then display a correct reading.

- Please order Panasonic battery with service part No. N4HHGMB00001 to replace.

CAUTION:

Danger of explosion if battery is incorrectly replaced.

Replace only with the same or equivalent type of battery recommended by the manufacturer.

Dispose of used batteries according to the manufacturer’s instructions.

The product that you have purchased contains a rechargeable battery. The battery is recyclable. At the end of its useful life, under various state and local laws, it may be illegal to dispose of this battery into the municipal waste stream. Check with your local solid waste officials for details in your area for recycling options or proper disposal.



A nickel metal hydride battery that is recyclable powers the product you have purchased.

Please call 1-800-8-BATTERY for information on how to recycle this battery.

Important Information

IMPORTANT SAFETY INSTRUCTIONS

When using your telephone equipment, basic safety precautions should always be followed to reduce the risk of fire, electric shock and injury to persons, including the following:

1. Read and understand all instructions.
2. Follow all warnings and instructions marked on this unit.
3. Unplug this unit from AC outlets before cleaning. Do not use liquid or aerosol cleaners. Use a damp cloth for cleaning.
4. Do not use this product near water, for example, near a bathtub, washbowl, kitchen sink, or laundry tub, in a wet basement or near a swimming pool.
5. Place this unit securely on a stable surface. Serious damage and/or injury may result if the unit falls.
6. Use only the power source marked on the unit. If you are not sure of the type of power supplied to your office, consult your dealer or local power company. The AC adaptor is used as the main disconnect device, ensure that the AC outlet is located/installed near the unit and is easily accessible.
7. Do not place objects on the power cord. Install the unit where no one can step or trip on the cord.
8. To reduce the risk of electric shock, do not disassemble this unit. Take the unit to an authorized servicenter when service is required. Opening or removing covers may expose you to dangerous voltages or other risks. Incorrect reassembly can cause electric shock when the unit is subsequently used.
9. Unplug this unit from the wall outlet and refer servicing to an authorized servicenter when the following conditions occur:
 - A. When the power supply cord or plug is damaged or frayed.
 - B. If liquid has been spilled into the unit.
 - C. If the unit has been exposed to water.
 - D. If the unit does not work normally by following the operating instructions. Adjust only controls covered by the operating instructions. Improper adjustment may require extensive work by an authorized servicenter.
 - E. If the unit has been dropped or physically damaged.
 - F. If the unit exhibits a distinct change in performance.
10. Avoid using a telephone other than cordless type during an electrical storm. There may be a remote risk of an electric shock from lightning.
11. Do not use the telephone to report a gas leak in the vicinity of the leak.

SAVE THESE INSTRUCTIONS

CAUTION

To reduce the risk of fire or injury to persons, read and follow these instructions.

1. Use only the power cord and batteries indicated in this manual.
2. Do not dispose of batteries in a fire. They may explode. Check with local codes for possible special disposal instructions.
3. Do not open or mutilate the battery. Released electrolyte is corrosive and may cause burns or injury to the eyes or skin. The electrolyte may be toxic if swallowed.
4. Exercise care in handling batteries in order not to short the battery to conductive materials such as rings, bracelets, and keys. The battery and/or conductor may overheat and cause burns.
5. Charge the battery provided with or identified for use with this product only in accordance with the instructions and limitations specified in this manual.
6. Danger of explosion if battery is incorrectly replaced.
Replace only with the same or equivalence type recommended by the manufacturer.

Important Information

Any changes or modifications not expressly approved by the party responsible for compliance could void the user's authority to operate this device.

WARNING:

TO PREVENT THE RISK OF FIRE OR ELECTRIC SHOCK, DO NOT EXPOSE THIS PRODUCT TO RAIN OR ANY TYPE OF MOISTURE.

Privacy of communications may not be ensured when using this phone.

For body worn operation, this device has been tested and meets FCC RF exposure guidelines when used with an accessory that contain no metal and that position the device a minimum of 1.5 cm (0.6 inches) from the body.

Use of other accessories may not ensure compliance with FCC RF exposure guidelines.

NOTE:

This device has been tested and found to comply with the limits for a Class B digital device, pursuant to Part 15 of the FCC Rules. These limits are designed to provide reasonable protection against harmful interference in a residential installation.

This device may not cause harmful interference, and must accept any interference received including interference that may cause undesired operation.

This device generates, uses, and can radiate radio frequency energy and, if not installed and used in accordance with the instructions, may cause harmful interference to radio communications. However, there is no guarantee that interference will not occur in a particular installation. If this device does cause harmful interference to radio or television reception, which can be determined by turning the device off and on, the user is encouraged to try to correct the interference by one or more of the following measures:

- Reorient or relocate the receiving antenna.
- Increase the separation between the device and receiver.
- Connect the device into an outlet on a circuit different from that to which the receiver is connected.
- Consult the dealer or an experienced radio/TV technician for help.

Some wireless telephones operate at frequencies that may cause interference to nearby TVs and VCRs. To minimize or prevent such interference, the base of the wireless telephone should not be placed near or on top of a TV or VCR. If interference is experienced, move the wireless telephone further away from the TV or VCR. This will often reduce or eliminate interference.

Operating near 2.4GHz electrical appliances may cause interference. Move away from the electrical appliances.

CAUTION:

This equipment is hearing aid compatible as defined by the FCC in 47 CFR Section 68.316.

When you hold the phone to your ear, noise might be heard in your Hearing Aid. Some Hearing Aids are not adequately shielded from external RF (radio frequency) energy. If noise occurs, use an optional headset accessory or the speakerphone option (if applicable) when using this phone. Consult your audiologist or Hearing Aid manufacturer about the availability of Hearing Aids which provide adequate shielding to RF energy commonly emitted by digital devices.

Important Information

The software contained in this equipment to allow user access to the network must be upgraded to recognize newly established network area codes and exchange codes as they are placed into service.

Failure to upgrade the premises systems or peripheral equipment to recognize the new codes as they are established will restrict the customer and the customer's employees from gaining access to the network and to these codes.

Environment — do not place the unit in rooms where the temperature is less than 5 °C (41 °F) or greater than 40 °C (104 °F).

Avoid excessive smoke, dust, mechanical vibration, shock, or direct sunlight.

Medical — consult the manufacturer of any personal medical devices, such as pacemakers or hearing aids, to determine if they are adequately shielded from external RF (radio frequency) energy. (The unit operates in the frequency range of 2,401 MHz to 2,480 MHz and emits 0.40 watts of RF [radio frequency] power.) Do not use the unit in health care facilities if any regulations posted in the area instruct you not to do so. Hospitals or health care facilities may be using unit that could be sensitive to external RF (radio frequency) energy.

Routine care — wipe the unit with a soft cloth. Do not use benzine, thinner, or any abrasive powder. When you leave the unit unused for a long period of time, unplug the AC adaptor from the outlet.

Hearing Aid Compatibility

This telephone provides magnetic coupling for hearing aids.

For Product Service

- Panasonic Servicenters are listed in the servicenter directory.
- Call 1-800-211-PANA (7262) for the location of an authorized servicenter.
- Panasonic's e-mail address for customer inquiries:
consumerproducts@panasonic.com
for customers in the USA or Puerto Rico ONLY

When you ship the product

- Carefully pack your unit, preferably in the original carton.
- Attach a letter, detailing the symptom, to the outside of the carton.

Symptom

- Send the unit to an authorized servicenter, prepaid and adequately insured.
- Do not send your unit to the Panasonic Consumer Electronics Company listed on the back cover or to executive or regional sales offices. These locations do not repair anything.

- This cordless telephone is designed for use in the United States of America. Sale or use of this product in other countries may violate local laws.
- Ce téléphone sans fil est conçu pour être utilisé aux États-Unis d'Amérique. La vente ou l'emploi de cet appareil dans certains autres pays peut constituer une infraction à la législation locale.
- Este teléfono sin cordón fue elaborado para uso en los Estados Unidos de América. La venta o el empleo de este producto en ciertos países puede constituir violación de la legislación local.
- このコードレス電話機は、日本国外での使用を目的として設計されており、日本国内での使用は法律違反となります。従って、当社では日本国内においては原則として修理などのサービスは致しかねます。

For your future reference

SERIAL NO. _____

(found inside the battery compartment)

DATE OF PURCHASE _____

NAME OF DEALER _____

DEALER'S ADDRESS _____

DEALER'S TEL. NO. _____

Panasonic Consumer Electronics Company
Division of Matsushita Electric Corporation of America
One Panasonic Way
Secaucus, NJ 07094

Panasonic Sales Company
Division of Matsushita Electric of Puerto Rico, Inc.
Ave. 65 de Infantería, Km.9.5
San Gabriel Industrial Park
Carolina, Puerto Rico 00985

<http://www.panasonic.com/csd>

Copyright:

This manual is copyrighted by Panasonic Communications Co., Ltd (PCC).

Under the applicable copyright laws, this manual may not be reproduced in any form, in whole or part, without the prior written consent of PCC and its licensee.

© 2003 Panasonic Communications Co., Ltd. All Rights Reserved.